

# Isolation Transformers

www.victronenergy.com

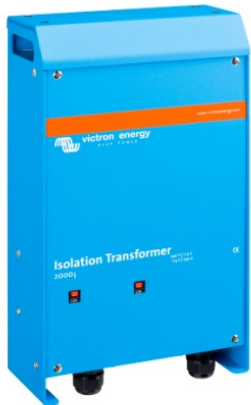

**Isolation Transformer  
2000W**



**Isolation Transformer  
3600W**

## Safety and prevention of galvanic corrosion

The Isolation Transformer eliminates any electrical continuity between AC shore power and the boat. It is essential for safety and eliminates the need for galvanic isolators and polarity alarms.

**Safety** is taken for granted in case of a normal on-shore installation. A fuse will blow or a GFCI (Ground Fault Current Interrupter) will trip in case of a short circuit or current leakage to ground. Connecting the ground wire of the shore-side supply to the metal parts of the boat will result in galvanic corrosion (see below). Bringing only the live and neutral wire on board results in an unsafe situation because GFCIs will not work nor will a fuse blow in case of a short circuit to a metal part on the boat.

**Galvanic corrosion** occurs when two dissimilar metals in electrical contact are simultaneously exposed to an electrically conducting fluid. Seawater and, to a lesser extent, fresh water are such fluids. In general, the more active alloy of the couple corrodes preferentially while the less active (more noble) material is cathodically protected. The rate of galvanic corrosion is a function of several variables including area ratios, conductivity of the fluid, temperature, nature of the materials, etc.

**It is a misunderstanding** that galvanic corrosion occurs only in metal and aluminium hulls. In fact it can occur on any boat as soon as a metallic part (the shaft and propeller) is in contact with water. Galvanic corrosion will quickly dissolve your sacrificial anodes, and attack the shaft, propeller and other metal parts in contact with water as soon as the boat is connected to the shore-side supply. It might therefore be tempting not to connect the ground conductor: this is however extremely dangerous because GFCIs will not work nor will a fuse blow in case of a short circuit to a metal part on the boat.

**The best solution** to avoid galvanic corrosion and at the same time prevent any unsafe situation is to install an Isolation Transformer to connect to the shore-side supply.

The Isolation Transformer eliminates any electrical continuity between shore power and the boat. The shore power is fed to the primary side of the transformer and the ship is connected to the secondary. The Isolation Transformer completely isolates the boat from the shore ground. By connecting all metal parts to the neutral output on the secondary side of the transformer, a GFCI will trip or a fuse will blow in case of a short circuit.

**Soft start** is a standard feature of a Victron Energy isolation transformer. It will prevent the shore power fuse from blowing due to the inrush current of the transformer, which would otherwise occur.

**It is also recommended**, for optimal safety, to connect the secondary neutral of the transformer to ground when the boat is out of the water.

## 3600 Watt Auto 115/230 V

This model will automatically switch to 115 V or 230 V supply, depending on input voltage.

Supply 88 V – 130 V: switches to 115 V supply

Supply 185 – 250 V: switches to 230 V supply range.

Note: The AC input voltage is raised by 1:1.05 ratio at the AC output.

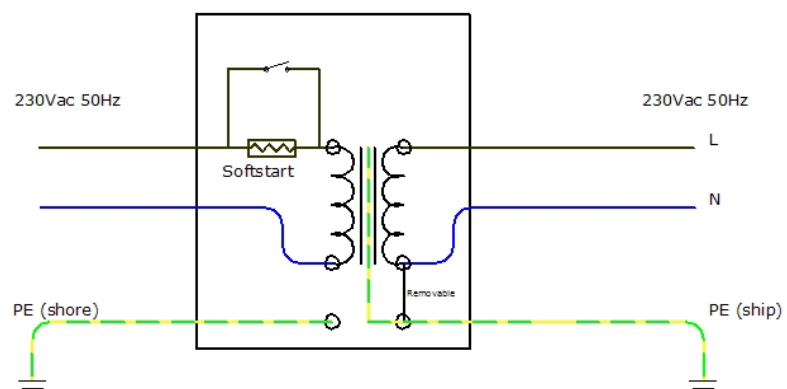

Isolation Transformers	2000 Watt (1)	3600 Watt (1)	3600 Watt Auto 115/230 V (1)	7000 Watt
Input	115 or 230 V	115 or 230 V	115 / 230 V Automatic 115/230 V switching	230 V
Output	115 or 230 V	115 or 230 V	115 or 230 V	230 V
Frequency	50/60 Hz	50/60 Hz	50/60 Hz	50/60 Hz
Rating	17 / 8,5 A	32 / 16 A	32 / 16 A	32 A
Soft start	Yes			
Transformer type	Toroidal (low noise, low weight)			
Input circuit breaker	yes			
ENCLOSURE				
Common Characteristics	Material: aluminium (blue RAL 5012)		Protection category: IP 21	
Weight	10 Kg	23 Kg	24 Kg	31 Kg
Dimensions (h x w x d), mm	375x214x110		362 x 258 x 218	
STANDARDS				
Safety	EN 60076			
1) Can be used as: 115 V to 115 V isolation transformer 115 V to 230 V isolation transformer	230 V to 230 V isolation transformer 230 V to 115 V isolation transformer			

